

Field Control Processor 270 (FCP270)



The Field Control Processor 270 is a distributed, optionally fault-tolerant, field-mounted controller that performs process control and alarming functions according to a user-defined control strategy.

FEATURES

- ▶ Performs regulatory, logic, timing, and sequential control together with connected Fieldbus Modules (FBMs)
- ▶ Performs data acquisition and alarm detection and notification
- ▶ Supports up to 32 200 Series FBMs - referring to both Compact or standard types
- ▶ Supports up to 128 200 Series FBMs (Compact or standard) with a Fieldbus Expansion Module 100 (FEM100)
- ▶ Supports up to 64 of the 100 Series FBMs
- ▶ No Fieldbus Communication Module is required
- ▶ Connects to The MESH control network via standard fiber optic 100 Mbps Ethernet
- ▶ Uses a rugged, die cast aluminum housing for mounting in a non-vented field enclosure
- ▶ Can operate in Class G3 harsh environments
- ▶ Is CE certified for field mounting in enclosures
- ▶ Supports both the 2 Mbps or 268 Kbps HDLC fieldbuses simultaneously with the FBI200 or FBI100, allowing connections to both 200 Series and 100 Series FBMs (affects the total number of each type of FBM supported).
- ▶ Offers unique, patented, fault-tolerant operation using two control modules to greatly improve reliability relative to other process controllers
- ▶ Uses versatile control algorithms and a wide variety of FBMs to provide control capabilities for a broad range of process applications

- ▶ Supports time synchronization using optional external time from GPS satellites
- ▶ Offers on-line image update of a fault-tolerant FCP270 without shutting down the process
- ▶ Uses soft letterbugs configurable via the I/A Series® system Letterbug Configurator running on a Pocket PC
- ▶ Supports self-hosting mode with I/A Series software v8.4-v8.8 or Foxboro Evo™ Control Core Services v9.0 or later

OVERVIEW

The Field Control Processor 270 (FCP270) is a distributed, optionally fault-tolerant, field-mounted controller module. The FCP270 performs regulatory, logic, timing, and sequential control together with connected Fieldbus Modules. It also performs data acquisition and alarm detection and notification. The FCP270 connects to The MESH control network via standard fiber optic 100 Mbps Ethernet.

The fault-tolerant version of the FCP270 consists of two processor modules. These modules install in adjacent FCP270 slots in a supported FCP270 baseplate for high speed communication between the modules (see Figure 1).

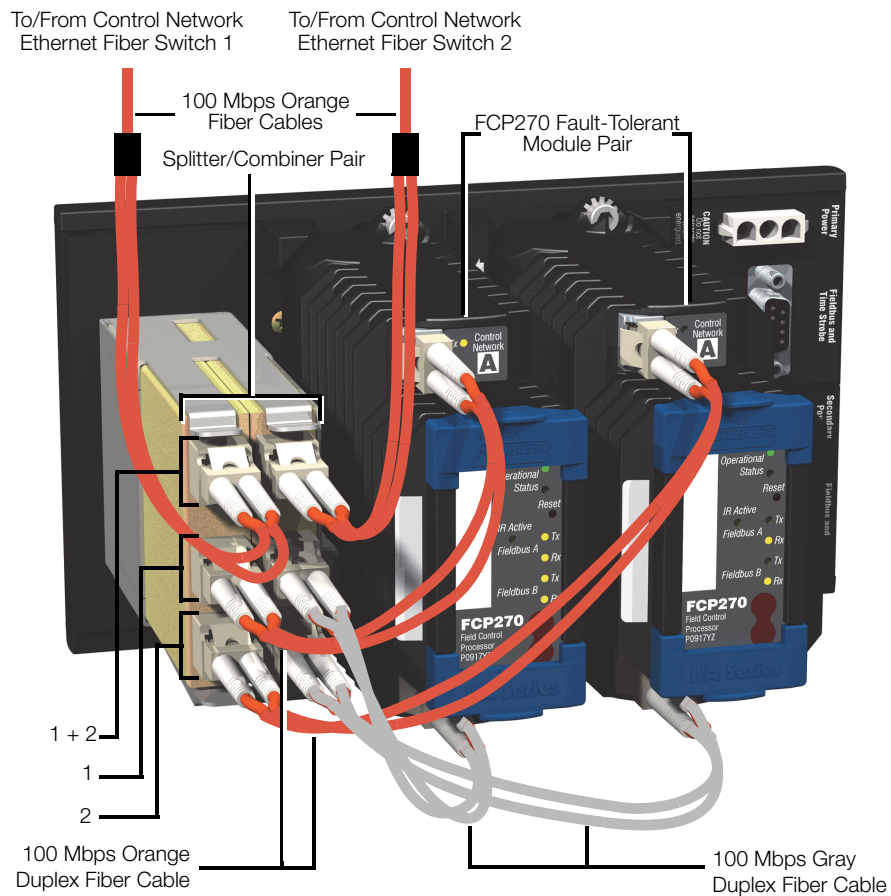

Figure 1. Fault-Tolerant FCP270 Module Pair Mounted on 2-Position Modular Baseplate

REMOTE MOUNTING

The FCP270 flattens and simplifies the Foxboro Evo Process Automation System architecture, which only requires field enclosures plus workstations and Ethernet switches. For more information on The MESH control network architecture, refer to PSS 21H-7C2 B3.

The field-mounted FCP270 is an integral part of the highly-distributed control network where controllers are closely aligned to specific process units mounted in close proximity to their I/O and the actual equipment being controlled. Coordination between process units takes place via a fiber optic 100 Mbps Ethernet network.

The FCP270 is packaged in a rugged, die cast aluminum housing that does not require venting due to its efficient design. The FCP270 is CE certified, and it can be mounted without expensive special cabinets to prevent electronic emissions. The FCP270 can be mounted in Class G3 harsh environments.

ENHANCED RELIABILITY (FAULT-TOLERANCE)

The unique and patented fault-tolerant operation of the FCP270 greatly improves reliability relative to other process controllers. The fault-tolerant version of the FCP270 consists of two modules operating in parallel, with two Ethernet connections to The MESH control network. The two FCP270 modules, married as a fault-tolerant pair, provide continuous operation of the controller in the event of virtually any hardware failure occurring within one module of the pair.

Both modules receive and process information simultaneously, and faults are detected by the modules themselves. One of the significant methods of fault detection is comparison of communication messages at the module external interfaces. Messages only leave the controller when both controllers agree on the message being sent (bit for

bit match). Upon detection of a fault, self-diagnostics are run by both modules to determine which module is defective. The non-defective module then assumes control without affecting normal system operations.

This fault-tolerant solution has the following major advantages over controllers that are merely redundant:

- ▶ No bad messages are sent to the field or to applications using controller data because no message is allowed out of the controller unless both modules match bit for bit on the message being sent.
- ▶ The secondary controller is synchronized with the primary one, which ensures up to the moment data in the event of a primary controller failure.
- ▶ The secondary controller will have latent flaws detected prior to any switchover because it is performing exactly the same operations as the primary controller.

SPLITTER/COMBINER

Fault-tolerant FCP270 modules connect to a pair of fiber optic splitter/combiners (see Figure 1) that connect to Ethernet switches in The MESH. For each module, the splitter/combiner pair provides separate transmit/receive fiber connections for Ethernet switch 1 and 2. Fiber cables are connected so that the splitter/combiners pass inbound traffic from either switch to both modules, and pass outbound traffic from the primary module to either switch.

The splitter/combiner pair mounts in an assembly that fastens to the FCP270 baseplates. The splitter/combiner is a passive device that uses no electrical power.

ENHANCED COMMUNICATIONS

The Foxboro Evo architecture uses The Mesh control network with 100 Mbps data communications between the FCP270s and the Ethernet switches (see Figure 2).

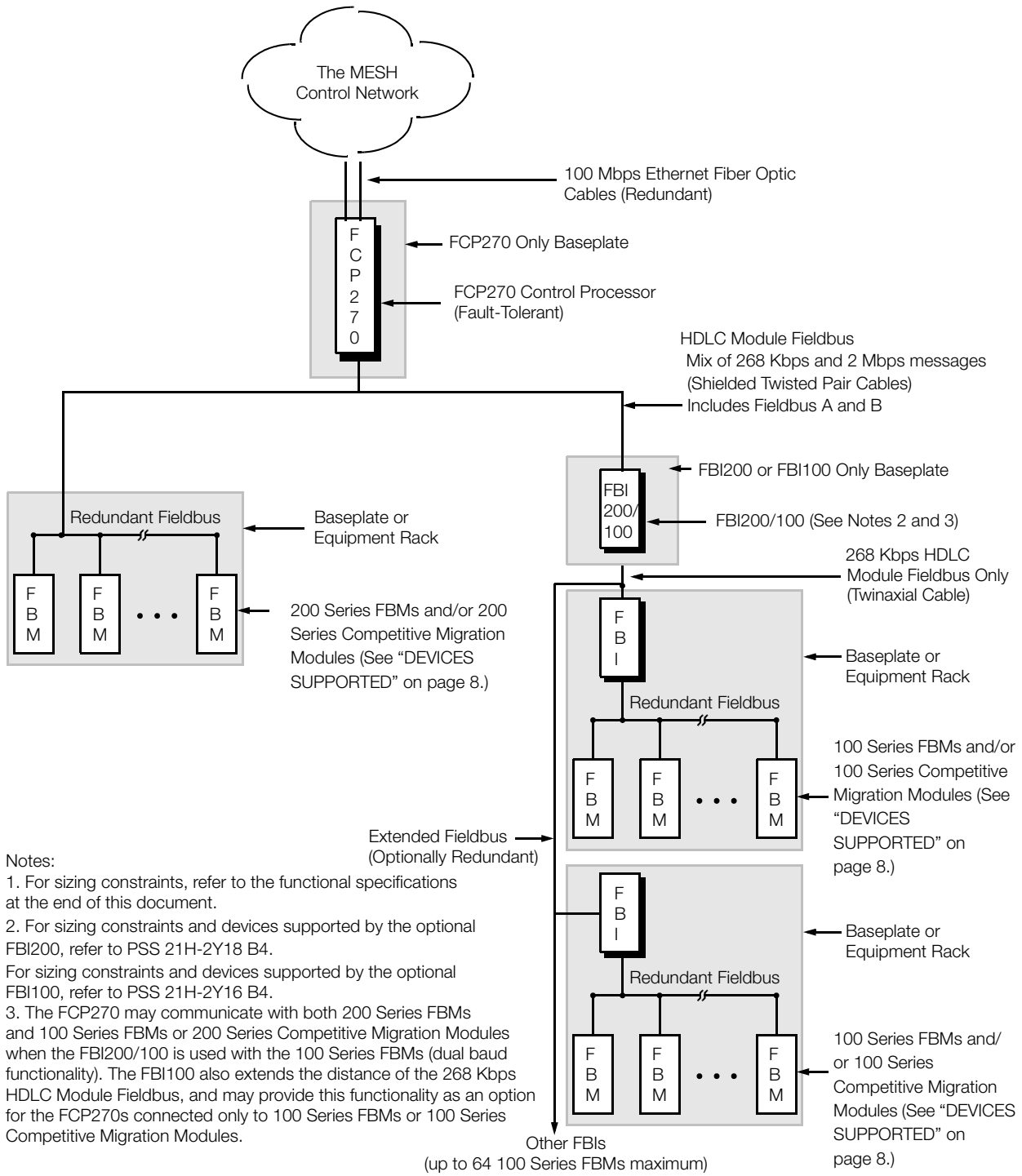

Notes:

1. For sizing constraints, refer to the functional specifications at the end of this document.
 2. For sizing constraints and devices supported by the optional FBI200, refer to PSS 21H-2Y18 B4.
 3. For sizing constraints and devices supported by the optional FBI100, refer to PSS 21H-2Y16 B4.
- The FCP270 may communicate with both 200 Series FBMs and 100 Series FBMs or 200 Series Competitive Migration Modules when the FBI200/100 is used with the 100 Series FBMs (dual baud functionality). The FBI100 also extends the distance of the 268 Kbps HDLC Module Fieldbus, and may provide this functionality as an option for the FCP270s connected only to 100 Series FBMs or 100 Series Competitive Migration Modules.

Figure 2. Typical FCP270 Network Configuration with Dual Baud Functionality (Simplified)

When used with the FBI200 or FBI100, the FCP270 can communicate with both the 100 Series and 200 Series FBMs (dual baud functionality, which requires I/A Series software level v8.4.1-v8.8 or Control Core Services v9.0 or later). It connects to the 2 Mbps HDLC fieldbus for communications to all 200 Series I/O FBMs and the Siemens APACS+™ and Westinghouse® competitive migration modules. When used the 100 Series FBMs and 100 Series competitive migration modules, the FCP270 connects to the 268 Kbps HDLC fieldbus, via the fieldbus splitter/terminator. (See “DEVICES SUPPORTED” on page 8.) The optional FBI200 or FBI100 filters the 2 Mbps messages from the 2 Mbps/268 Kbps mixed HDLC fieldbus and only passes on the 268 Kbps messages for the 100 Series FBMs.

The FCP270 can also communicate with serial and Ethernet devices, such as PLCs, via Field Device System Integrators. This allows you to connect to new device interfaces without any changes to the controller software.

UPGRADE OPTIONS

Multiple options are available for replacing control processors controlling 100 Series FBMs with the FCP270 in a Foxboro Evo network.

Cabling the 100 Series FBMs or Migration products to an FCP270 baseplate consists of extending the remote 268 Kbps fieldbus between enclosures. This is accomplished using termination cable assemblies (TCAs) and Fieldbus Isolators (FBIs) to provide connections between primary and extended fieldbus segments. For direct connections from the FCP270 to the 100 Series FBMs, the maximum fieldbus length is 1 km (3200 ft). An FBI100 can be used to extend the fieldbus to 1.83 km (6000 ft).

As with earlier generations of control processors, up to 64 Fieldbus Modules (including 100 Series FBM Expander Modules) attach to the extended bus through Fieldbus Isolators. (Up to 24 Fieldbus Modules, excluding expansion modules, can connect to each isolator.)

FIELDBUS EXPANSION MODULE 100 (FEM100)

The FEM100 module increases the number of 200 Series (or equivalent) FBMs supported for the FCP270 modules to up to 128 FBMs for typical control usage. The FEM100 provides four Expanded Fieldbus ports, each of which is capable of communicating with up to thirty-two FBMs. This is illustrated in Figure 3.

The FCP270 requires I/A Series software v8.3-v8.8 or Control Core Services v9.0 or later to support the FEM100 module.

The FCP270 baseplate may connect to a Two-Slot Expansion Baseplate which accommodates a single or pair of FEM100s. A Four-Slot Expansion Baseplate is also provided which can accommodate up to two fault-tolerant FCP270s and a single or pair of FEM100s.

For a description of these baseplates, refer to PSS 21H-2W6 B4.

A pair of FEM100 modules provides redundancy for the Extended Fieldbuses. When both modules are active, the FCP270 sends and receives communications across both A and B buses. In the case of a FEM100 module failure, the FCP270 switches all traffic to the bus with the available FEM100 module until the failed module is replaced.

FBI200/FBI100 FIELDBUS ISOLATOR/FILTER

The FBI200 and FBI100 Fieldbus Isolator/Filters are designed to filter and isolate 2 Mbps communications from an FCP270 to the Fieldbus Isolator (FBI) which requires 268 Kbps signals for 100 Series FBMs and similar Migration modules. This enables the FCP270 to communicate with both 200 Series FBMs (over 2 Mbps signals) and 100 Series FBMs (over 268 Kbps signals) simultaneously when the FBI100 is installed as specified.

The FBI100 also extends the length of the 268 Kbps module Fieldbus from the FCP270 to 100 Series FBMs and similar competitive migration modules up to 1830 m (6000 ft) over a twinaxial Fieldbus cable. See Figure 2 on page 4.

For more information on the FBI200, refer to PSS 21H-2Y18 B4.

For more information on the FBI100, refer to PSS 21H-2Y16 B4.

ON-LINE IMAGE UPDATE

For fault-tolerant FCP270 modules, on-line image update replaces the executable image (operating system) of a running FCP270 with a newer image without having to shut down the equipment being controlled by the FCP270. New product enhancements can be brought on-line in 1.5 seconds for heavily loaded controllers; less for lightly loaded controllers.

Because the FCP270 contains its executable image in internal flash memory, and has sufficient RAM to hold a new executable image at the same time, on-line image updates are now much easier to perform.

TIME SYNCHRONIZATION, SOE, TDRA

The Foxboro Evo system supports time synchronization using either an externally maintained optional source of Universal Coordinated Time (UTC) from GPS satellites or an internal source using proprietary software. Controllers that receive time updates via the external time source synchronize their FBMs to 1 ms. For more information on time synchronization, refer to PSS 21S-1C2 B3.

Time stamping is used for alarm messages, values sent to the historian, and the new Sequence Of Events (SOE) and Transient Data Recorder and Analyzer (TDRA) features.

SOE data are discrete points that are time stamped at the FBM, optionally to 1 ms, and sent to the workstation on a change basis. TDRA data are analog points that are time stamped at the FBM and sent to the workstation every 10 ms. These new features are supported by client software in the workstation. For information on this new software, refer to PSS 21S-2B9 B4 and PSS 21S-2B10 B4.

SOFTWARE FEATURES

The FCP270 performs regulatory, logic, timing, and sequential control, as well as data acquisition, alarm detection, and alarm notification. Process variables are controlled using time-proven algorithms (mathematical computations performing specific functions). The algorithms are contained in functional control blocks, which on-site process engineers configure to implement the desired control strategies.

The versatility of the algorithms, coupled with the variety of FBMs available, provides control capabilities suited to a broad range of process applications. Control strategies ranging from simple feedback and cascade loops to highly sophisticated feedforward, nonlinear, and complex characterization control schemes are readily implemented.

The FCP270 also supports the following features:

- ▶ Infrared communications with the controller enables you to set and read the controller letterbug via the Letterbug Configurator
- ▶ Alarm enhancements to function blocks: re-alarmed on changes to alarm priority, re-alarmed based upon a configurable time delay deadband, and alarm suppression based upon time
- ▶ Optional UTC external time synchronization
- ▶ Improved controller performance.
- ▶ Optional self-hosting mode (I/A Series software v8.4-v8.8 or Control Core Services v9.0 or later) allows the FCP270 to start up and run, executing its configured control scheme using the checkpoint file stored in flash memory. This allows the FCP270 to boot itself with a valid control database even if its host workstation is not present.

Self-Hosting Feature, Available with 200 Series FBMs Only

The self-hosting feature is recommended only for use in FCP270s which are used with 200 Series FBMs. All of the information necessary to reboot 200 Series FBMs is included in non-volatile flash memory on the FCP270. However, the flash memory on the 100 Series FBMs and related products on the 268k fieldbus does not include this information, and they require the workstation host to be present to reboot. More details on the self-hosting feature are available in *DIN Rail Mounted FBM Subsystem User's Guide* (B0400FA).

DEVICES SUPPORTED

The FCP270 supports the following devices on the 2 Mbps module Fieldbus:

- ▶ All 200 Series FBMs (FBM201, FBM202, and so forth) - both Compact and standard types
- ▶ Field Device Systems Integrator (FDSI) modules
- ▶ Intrinsically Safe I/O Subsystem (ISCM)
- ▶ DCS Fieldbus Modules for Siemens APACS+™ Systems
- ▶ DCS Fieldbus Modules for Westinghouse WDPF® Systems.
- ▶ DCS Fieldbus Modules for Fisher's PROVOX® Series 20 Migration with HART.
- ▶ DCS Fieldbus Modules for Honeywell® TDC 2000 Systems with HART.

The FCP270 supports the following devices on the 268 Kbps fieldbus:

- ▶ 100 Series FBMs (FBM01, FBM02, and so forth)
- ▶ Fieldbus Cluster I/O via FBP10 fieldbus processor module
- ▶ Foxboro® Hydrostatic Interface Unit (HIU)⁽¹⁾
- ▶ Foxboro Mass Flowmeter
- ▶ Foxboro Panel Display Stations
- ▶ SPECTRUM™ Migration Integrators
- ▶ SPEC 200™ Control Integrators
- ▶ SPEC 200 MICRO™ Control Integrators
- ▶ SPEC 200 CCM Control Integrators
- ▶ DCS Fieldbus Modules for Honeywell® TDC 2000 and TDC 3000 Systems
- ▶ DCS Fieldbus Modules for Bailey® Net90 and Infi90 Systems

(1) Although FBM23 (HIU) IOM software is included with I/A Series software v8.x or Control Core Services v9.0 or later, the module's configurator, Intelligent Transmitter Maintenance Workbench (IT_Maint), is not supported. You must configure all FBM23s with the hand-held terminal FIU. Refer to *Configuration - Handheld Terminal (FIU)*, Foxboro M&I document number MI 020-065.

- ▶ DCS Fieldbus Modules for Fisher's PROVOX® Series 10, Series 20, and Controller Series Systems.

The Foxboro Gas Chromatograph is not supported.

BASEPLATE

The FCP270 is installed on a modular, DIN rail mounted baseplate in a dedicated slot that is keyed for the controller, so other modules cannot be placed in these slots. For further information on DIN rail mounted equipment, refer to PSS 21H-2W1 B3 and PSS 31H-2COV B3.

LED INDICATORS

Light-emitting diodes (LEDs) on the front of the FCP270 module provide visual indication of the:

- ▶ FCP270 operational status
- ▶ Communications activity of The MESH control network A and B links
- ▶ Communications activity of fieldbus A and B
- ▶ Infrared communications activity.

The MESH control network path Tx LEDs indicate which controller is primary as well as the network path it is using; these LEDs are only active on the primary module.

FUNCTIONAL SPECIFICATIONS

Processor Type

CONTROL PROCESSOR

Microprocessor-based AMD Elan 520 (running at 100 MHz) with stored programs, using high-speed communication capability. In addition, the CommControl™ ASIC with an internal 80186 controls the communication to the I/O Modules (FBMs).

Memory

SIZE

16 MB SDRAM
32 MB flash memory

ERROR DETECTION

ECC providing single-bit error detection and correction as well as multiple-bit error detection.

Process I/O Communications (with FBMs)

MODULE FIELDBUS

Type
HDLC

Transmission Rate
2 Mbps for 200 Series FBMs or
268 Kbps for 100 Series FBMs

Process I/O Capacity

2 MBPS HDLC FIELDBUS

200 Series FBMs
32 maximum without FEM100 modules or with FEM100 modules, control usage supports capability for up to 128 FBMs. Refer to *FCP270 Sizing Guidelines* (B0700AV) for sizing constraints.
Competitive Migration Modules
Refer to the device specific Product Specification Sheets

268 KBPS HDLC FIELDBUS

100 Series FBMs
64 maximum depending on control processor sizing constraints (refer to *FCP270 Sizing Guidelines* [B0700AV]).
Competitive Migration Modules
Refer to the device specific Product Specification Sheets

Process I/O Capacity (Cont.)

MIX OF 2 MBPS HDLC FIELDBUS AND 268 KBPS HDLC FIELDBUS

In addition to previous sizing constraints, the total number of 100 Series and 200 Series FBMs and/or competitive migration modules supported (mixed) is 64 modules, maximum.

Memory Allocation for Blocks

5.8 MB

Maximum Number of Blocks Configured

The maximum number of blocks that can be configured for the FCP270 (or fault-tolerant FCP270 pair) is 4000.

Block Executions Per Second

10,000 blocks/second, maximum

Maximum Number of Blocks Processed

The number of blocks that can be processed per block processing cycle (BPC) time interval depends on scan periods and block type selection. These blocks include all types (control blocks, ECBs, compounds, data blocks, and so forth). For sizing guidelines, refer to *FCP270 Sizing Guidelines* (B0700AV).

Minimum Block Processing Cycle (BPC)

50 ms

Sequence Block Size

32 KB maximum for each block

Maximum Number of IPC Connections

131; 100 connections for source points; 30 connections for sink points; 1 connection for internal use only.

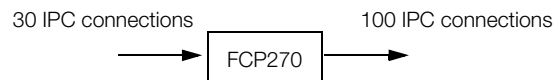

Maximum Number of OM Sink Lists

50

Maximum OM Scanner Database

12,000 points for BPC ≥ 200 ms
5,000 points for BPC ≤ 100 ms

Maximum Number of OM Sink Points

7,500

FUNCTIONAL SPECIFICATIONS (CONTINUED)

Configurable Block Periods

0.05, 0.1, 0.2, 0.5, 0.6, 1, 2, 5, 6, 10, 30 seconds
1, 10, 60 minutes

Block Processing Cycle

0.05, 0.1, 0.2, 0.5 and 1.0 seconds, selectable at system configuration time

Time to Marry Fault-Tolerant Modules

Less than 1 second

Internal Diagnostics

Self-checking performed at power-up. Run-time checks and the watchdog timer function performed during operation.

Infrared Communications

Letterbug assignment via the Letterbug Configurator. Letterbug or Hardware ID readout via the Letterbug Configurator.

Power Requirements

INPUT VOLTAGE (REDUNDANT VOLTAGE)

24 V dc typical

CONSUMPTION (PER NON-FAULT-TOLERANT MODULE)

8.5 W, maximum

Regulatory Compliance

ELECTROMAGNETIC COMPATIBILITY (EMC)

European EMC Directive 89/336/EEC

Meets: EN 50081-2 Emission standard

EN 50082-2 Immunity standard

EN 61326 Annex A (Industrial Levels)

CISPR 11, Industrial Scientific and Medical (ISM) Radio-frequency Equipment -

Electromagnetic Disturbance Characteristics - Limits and Methods of Measurement

Meets Class A Limits

IEC 61000-4-2 ESD Immunity

Contact 4 kV, air 8 kV

IEC 61000-4-3 Radiated Field Immunity

10 V/m at 80 to 1000 MHz

IEC 61000-4-4 Electrical Fast

Transient/Burst Immunity

±2 kV on I/O, dc power and communication lines

IEC 61000-4-5 Surge Immunity

±2 kV on ac and dc power lines; ±1 kV on I/O and communications lines

IEC 61000-4-6 Immunity to Conducted Disturbances Induced by Radio-frequency Fields

10 V (rms) at 150 kHz to 80 MHz on I/O, dc power and communication lines

IEC 61000-4-8 Power Frequency Magnetic Field Immunity

30 A/m at 50 and 60 Hz

PRODUCT SAFETY

Underwriters Laboratories (UL) for U.S. and Canada

UL/UL-C listed as suitable for use in UL/UL-

C listed Class I, Groups A-D; Division 2;

temperature code T4 enclosure based

systems. These modules are also UL and

UL-C listed as associated apparatus for

supplying non-incendive communication

circuits for Class I, Groups A-D hazardous

locations when connected to specified

I/A Series/Foxboro Evo system Fieldbus

Modules as described in the *DIN Rail*

Mounted Subsystem User's Guide

(B0400FA). Communications circuits also

meet the requirements for Class 2 as defined

in Article 725 of the National Electrical Code

(NFPA No.70) and Section 16 of the

Canadian Electrical Code (CSA C22.1).

Conditions for use are as specified in the

DIN Rail Mounted Subsystem User's Guide

(B0400FA).

EUROPEAN LOW VOLTAGE DIRECTIVE 73/23/EEC AND EXPLOSIVE ATMOSPHERES (ATEX) DIRECTIVE 94/9/EC

CENELEC (DEMKO) certified as EEx nAnL

IIC T4 for use in CENELEC certified Zone 2

enclosure certified as associated apparatus

for supplying non-incendive field circuits for

Zone 2, Group IIC, potentially explosive

atmospheres when connected to specified

I/A Series system Fieldbus Modules as

described in the *DIN Rail Mounted*

Subsystem User's Guide (B0400FA).

FUNCTIONAL SPECIFICATIONS (CONTINUED)

SECURITY

Wurldtech Achilles Certification™ Level One

ENVIRONMENTAL SPECIFICATIONS(2)

Operating

TEMPERATURE

0 to +60°C (+32 to +140°F)

RELATIVE HUMIDITY

5 to 95% (Noncondensing)

ALTITUDE

-300 to +3,000 m (-1,000 to +10,000 ft)

CONTAMINATION

Class G3 (Harsh) as defined in ISA Standard, S71.04. Pollution degree 2 as defined in IEC 664-1.

VIBRATION

0.5 g (5 to 500 Hz)

Storage

TEMPERATURE

-40 to +70°C (-40 to +158°F)

RELATIVE HUMIDITY

5 to 95% (Noncondensing)

ALTITUDE

-300 to +12,000 m (-1,000 to +40,000 ft)

PHYSICAL SPECIFICATIONS

Configuration

Single processor module. The fault-tolerant version consists of two processor modules, with an interconnecting fault-tolerant connector integral to the baseplate.

Mounting

May be placed in device specific 2- or 4-position baseplates designed for horizontal or vertical mounting.

For the fault-tolerant FCP270, the two modules must be mounted in dedicated slots to allow for interconnecting fault-tolerant communication.

Dimensions - Module

HEIGHT

103 mm (4.04 in)

114 mm (4.50 in) including mounting lugs

WIDTH

51.5 mm (2.03 in)

DEPTH

147 mm (5.80 in)

Mass (Maximum)

0.6 kg (1.3 lb) for a single, non-fault-tolerant module.

Fiber Optic Cabling – Ethernet Switch to FCP270

CONNECTORS

Ethernet Switch Connector

One MT-RJ Connector

FCP270 or Splitter/Combiner Connector

Two ceramic type LC connectors with clip

FIBER OPTIC CABLE

Cable Material

Multimode fiber (MMF) 62.5/125 µm plenum

Cable Lengths

3 m (9.9 ft), 15 m (49.5 ft), 50 m (165 ft)

greater than 50 m – user supplied

Maximum Length

2 km (6,560 ft) from the Ethernet switch to the FCP270.

(2) The environmental limits of this module may be enhanced by the type of enclosure containing the module. (Refer to the applicable Product Specification Sheet (PSS) which describes the specific type of enclosure that is to be used.)

PHYSICAL SPECIFICATIONS (CONTINUED)

Fiber Optic Cabling – Splitter/Combiner to FCP270

CONNECTORS

Two ceramic type LC connectors with clip on each end

FIBER OPTIC CABLE

Cable Material

Multimode fiber (MMF) 62.5/125 μm

Cable Lengths

0.5 m (1.6 ft), 1.0 m (3.3ft), 3.0 m (9.9 ft), 15 m (49.5 ft), 50 m (165 ft) greater than 50 m – user supplied

Maximum Length

2 km (6,560 ft) total from the Ethernet switch to the FCP270, including the cabling to the splitter/combiner.

FCP270 Fieldbus without FCM2Fs

The cable length of the Fieldbus cannot exceed 60 m (198 ft) (see Figure 4).

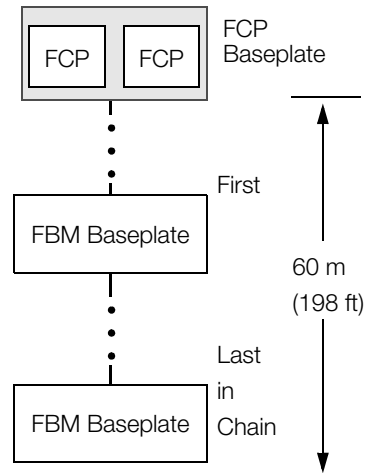

Figure 4. Fieldbus Cable Length Restrictions

PHYSICAL SPECIFICATIONS (CONTINUED)

FCP270 Fieldbus with FCM2Fs

Each FCP/FCM drives a segment of interconnected baseplates of up to 60 m (198 ft). Up to four pairs of FCM2Fxs can be used in a Fieldbus network (see Figure 5).

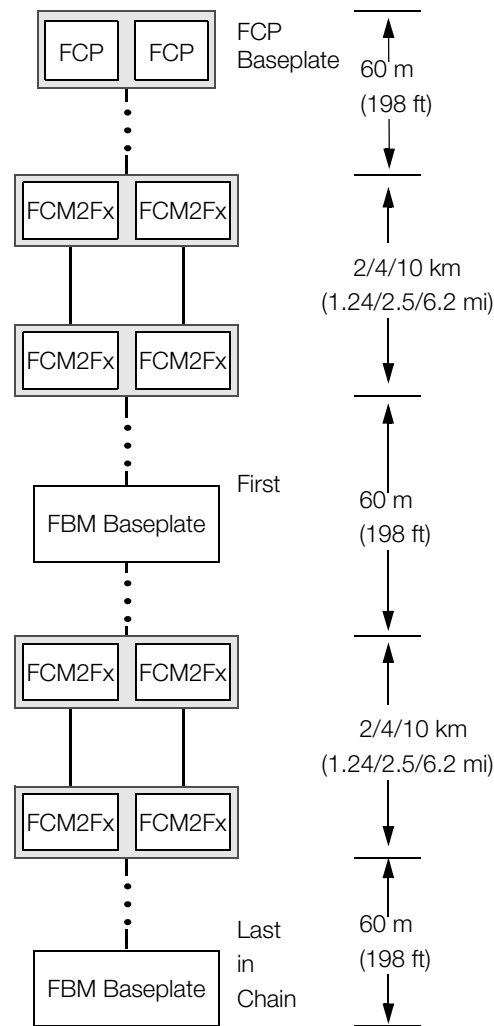

Figure 5. Fieldbus Cable Length Restrictions w/FCM2Fs Between FCP and FBM Baseplates, and Between Baseplates

PHYSICAL SPECIFICATIONS (CONTINUED)

FCP270 Fieldbus and Expanded Fieldbuses (1-4) without FCM2Fs
The cable length of the Fieldbus cannot exceed 60 m (198 ft) (see Figure 6).

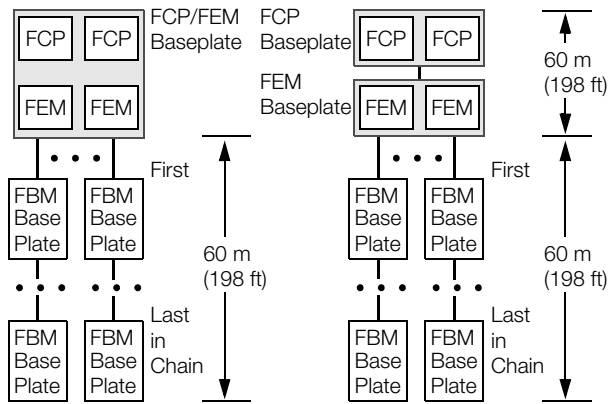
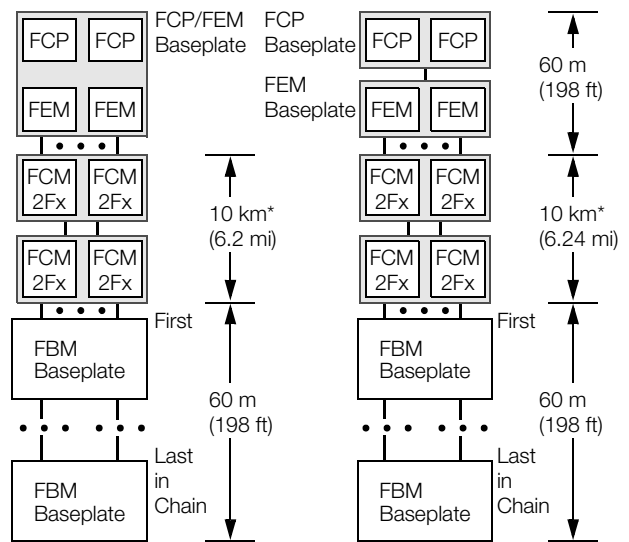

Figure 6. Expanded Fieldbus Cable Length Restrictions

FCP270 Fieldbus and Expanded Fieldbuses (1-4) with FCM2Fs
Each FCP/FCM drives a segment of interconnected baseplates of up to 60 m (198 ft). Up to four pairs of FCM2Fxs can be used in each Expanded Fieldbus network (see Figure 7).



* 20 km distance is allowed through the use of four pairs of FCM2F10s, as shown in Figure 5 above.

Figure 7. Expanded Fieldbus Cable Length Restrictions w/FCM2Fs